

## BP3 - BEND PRESSED 30°

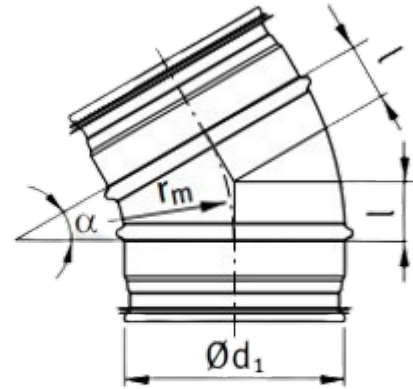

$$r_m \approx 1 \cdot d_1$$

- Galvanised steel
- EPDM rubber gasket
- Pressed
- Gasket is positioned by returned edges

$\varnothing d_1$	l (mm)	weight (kg)
80	27	0,15
100	27	0,18
125	33	0,20
160	43	0,32
200	54	0,62