

BS6 - BEND SEGMENTED 60°

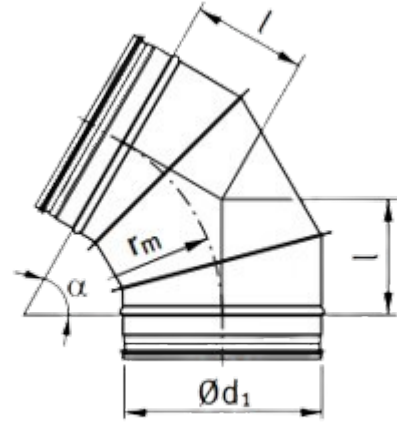

$$r_m \approx 1 \cdot d_1$$

- Galvanised steel
- EPDM rubber gasket
- Segments connected with lock
- Gasket is positioned by returned edges

$\varnothing d_1$	l (mm)	weight (kg)
250	144	1,48
315	182	2,20
355	205	2,80
400	231	3,47
450	260	4,70
500	289	6,00
560	323	7,40
630	364	9,20